

QRx118S
18" Subwoofer
Loudspeaker System

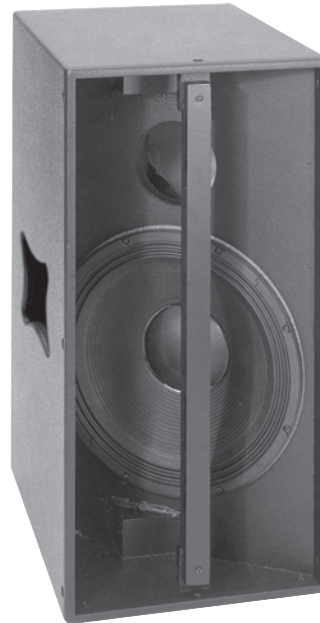

Key Features:

- Loaded with a concert-proven EVX-180B woofer for maximum power-handling
- Available in black and by special order in white
- EV comfort-lift handles
- Comes with metal socket for elevating a two-way system
- 13-ply birch plywood enclosure finished in Futura™



General Description:

The QRx-118S is a dedicated subwoofer loudspeaker system that incorporates the EVX-180B 4-inch voice coil driver for maximum LF reproduction power with minimum box volume. This vented, 600-watt system easily provides 131 dB SPL¹ @1 w/1 m (137 dB peak¹) at full power in a rectangular enclosure that is stable and readily stacks for extra energy or slides easily under even the lowest stages. The QRx-118S cabinet has recessed side safety handles for ease of transport and includes 1-3/8-inch pole mount receptacle for use with full range cabinets without the need for extra mounting stands. The rear of the cabinet includes four 1/4-20 threaded T-nuts for affixing casters or dollies.

Technical Specifications:

System Configuration:	Subwoofer
Freq. Response (-3 dB):	45 Hz - 150 Hz
Freq. Response (-10 dB):	30 Hz - 250 Hz
Recommended High-Pass Frequency:	36 Hz, 12 dB/octave minimum
Recommended Crossover Frequency Range:	100 Hz, 24 dB/octave
Axial Sensitivity, SPL ¹ :	98 dB (1 watt@1m)
Max Calculated SPL Long Term ¹ :	131 dB
Peak ¹ :	137 dB
Long-Term Power Handling:	600 watts
Short-Term Power Handling:	2,400 watts
LF Transducer:	EVX180B Cast Frame 18-inch Woofer, 4" Voice Coil
Impedance:	8 ohms
Enclosure Material:	13-Ply Birch Plywood
Grille:	Powder-Coated 16-GA Steel, Fabric Backed
Input connectors:	(2) Neutrik Speakon NL4's
Dim (H x W x D):	35.5" x 17.7" x 23.6" (902mm x 450mm x 599mm)
Net Weight:	100 lbs (45 kg)
Shipping Weight:	109 lbs (49 kg)

¹ Half Space Measurements.

Block Diagram:

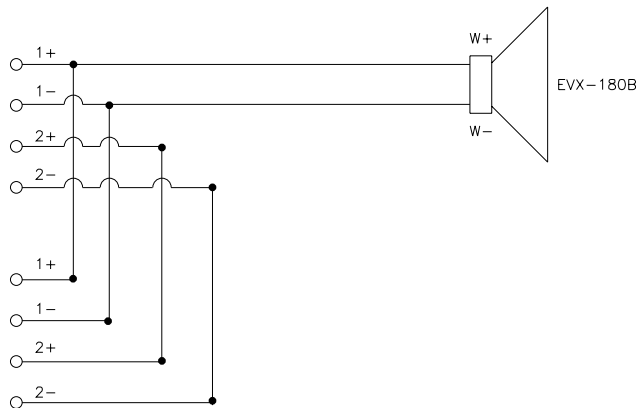

Frequency Response:

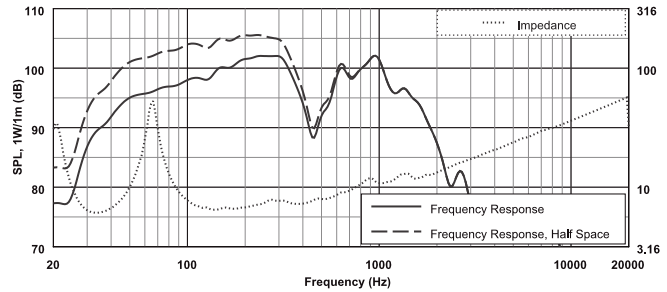

Performance Match:

- EV P1202 Modular Precision Amplifier
- M-118 Plug-in Controller Module
- EV P3000 Precision Series Amplifier
- Dx38 Digital Sound System Controller
- AC-One Analog Sound System Controller

QRx118S Part Numbers:

- 301023-001 QRx-118S, Black Futura finish
- 301023-002 QRx-118S, White finish

Dimension Drawings :

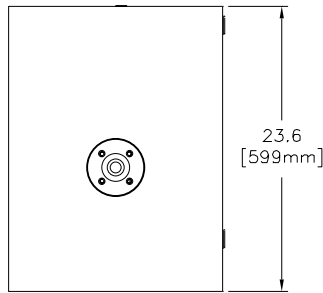

Top View

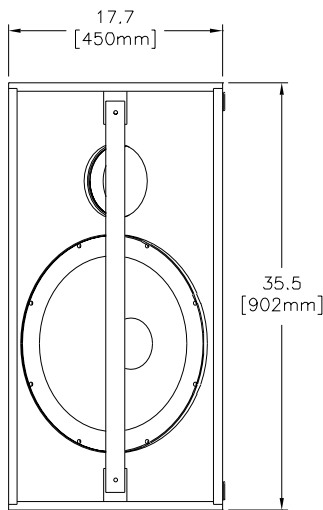

Front View

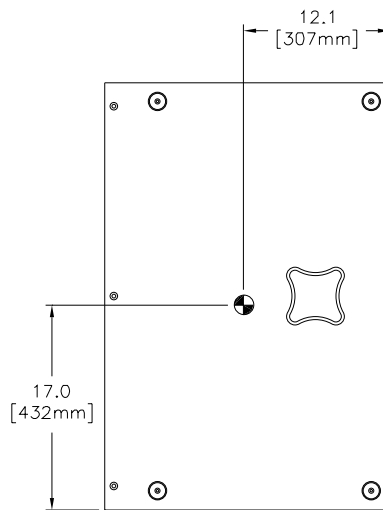

Side View

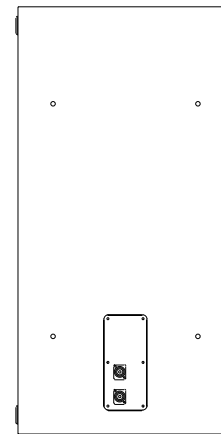

Rear View



WARNING: Suspending any object is potentially dangerous and should only be attempted by individuals who have a thorough knowledge of the techniques and regulations of rigging objects overhead. Electro-Voice® strongly recommends that QRx speakers be suspended taking into account all current national, federal, state and local regulations. It is the responsibility of the installer to ensure that QRx speakers are safely installed in accordance with all such regulations. If QRx speakers are suspended, Electro-Voice® strongly recommends that the system be inspected at least once a year. If any sign of weakness or damage is detected, remedial action should be taken immediately.



12000 Portland Avenue South, Burnsville, MN 55337
Phone: 952/884-4051, Fax: 952/884-0043

www.electrovoice.com

© Telex Communications, Inc. 4/2003
Part Number 38109-987 Rev D

U.S.A. and Canada only. For customer orders, contact Customer Service at:
800/392-3497 Fax: 800/955-6831

Europe, Africa, and Middle East only. For customer orders, contact Customer Service at:
+ 49 9421-706 0 Fax: + 49 9421-706 265

Other International locations. For customer orders, contact Customer Service at:
+ 1 952 884-4051 Fax: + 1 952 736-4212

For warranty repair or service information, contact the Service Repair department at:
800/685-2606

For technical assistance, contact Technical Support at: 866/78AUDIO

Specifications subject to change without notice.