

AVerMedia® AVerVision SPC300

User Manual



AVerMedia

AVerMedia®
Digital Document Camera



P/N 300AACFP
Made in Taiwan

FCC NOTICE (Class A)

This device complies with Part 15 of the FCC Rules. Operation is subject to the following two conditions: (1) this device may not cause harmful interference, and (2) this device must accept any interference received, including interference that may cause undesired operation.

Federal Communications Commission Statement

NOTE- This equipment has been tested and found to comply with the limits for a Class A digital device, pursuant to Part 15 of the FCC Rules. These limits are designed to provide reasonable protection against harmful interference when the equipment is operated in a commercial environment. This equipment generates, uses and can radiate radio frequency energy and, if not installed and used in accordance with the instructions, may cause harmful interference to radio communications. Operation of this equipment in a residential area is likely to cause harmful interference in which case the user will be required to correct the interference at his own expense.

CAUTION ON MODIFICATIONS

To comply with the limits for the Class A digital device, pursuant to Part 15 of the FCC Rules, this device must be installed in computer equipment certified to comply with the Class A limits. All cables used to connect the computer and peripherals must be shielded and grounded. Operation with non-certified computers or non-shielded cables may result in interference to radio or television reception.

Changes and modifications not expressly approved by the manufacturer could void the user's authority to operate this equipment.

European Community Compliance Statement (Class A)

This product is conformity with the protection requirements of EU Council Directives 89/336/EEC amended by 92/31/EEC on the laws of the Member States relating to electromagnetic compatibility.

Warning - This is a Class A product. In a domestic environment this product may cause radio interference in which case the user may be required to take adequate measures to correct this interference.

DISCLAIMER

No warranty or representation, either expressed or implied, is made with respect to the contents of this documentation, its quality, performance, merchantability, or fitness for a particular purpose. Information presented in this documentation has been carefully checked for reliability; however, no responsibility is assumed for inaccuracies. The information contained in this documentation is subject to change without notice.

In no event will AVerMedia be liable for direct, indirect, special, incidental, or consequential damages arising out of the use or inability to use this product or documentation, even if advised of the possibility of such damages.

TRADEMARKS

AVerMedia is registered trademarks of AVerMedia TECHNOLOGIES, Inc. IBM PC is a registered trademark of International Business Machines Corporation. Macintosh is a registered trademark of Apple Computer, Inc. Microsoft is a registered trademark and Windows is a trademark of Microsoft Corporation. All other products or corporate names mentioned in this documentation are for identification and explanation purposes only, and may be trademarks or registered trademarks of their respective owners.

COPYRIGHT

© 2007 by AVerMedia TECHNOLOGIES, Inc. All rights reserved. No part of this publication may be reproduced, transmitted, transcribed, stored in a retrieval system, or translated into any language in any form by any means without the written permission of AVerMedia TECHNOLOGIES, Inc.



THE MARK OF CROSSED-OUT WHEELED BIN INDICATES THAT THIS PRODUCT MUST NOT BE DISPOSED OF WITH YOUR OTHER HOUSEHOLD WASTE. INSTEAD, YOU NEED TO DISPOSE OF THE WASTE EQUIPMENT BY HANDING IT OVER TO A DESIGNATED COLLECTION POINT FOR THE RECYCLING OF WASTE ELECTRICAL AND ELECTRONIC EQUIPMENT. FOR MORE INFORMATION ABOUT WHERE TO DROP OFF YOUR WASTE EQUIPMENT FOR RECYCLING, PLEASE CONTACT YOUR HOUSEHOLD WASTE DISPOSAL SERVICE OR THE SHOP WHERE YOU PURCHASED THE PRODUCT.

Battery Safety Information

- Store the batteries in a cool dry place.
- Do not dispose of used batteries in domestic waste. Dispose of batteries at special collection points or return to point of sale if applies.
- Remove the batteries during long periods of non-use. Always remove exhausted batteries from the remote control. Battery leakage and corrosion can damage this remote control, dispose of batteries safely.
- Do not mix old and new batteries.
- Do not mix different types of batteries: alkaline, standard (carbon-zinc) or rechargeable (nickel-cadmium).
- Do not dispose of batteries in a fire. The batteries may explode or leak.
- Never short circuit the battery terminals.

Table of Contents

Introduction	1
Package Contents	1
AVerMedia® AVerVision SPC300 Parts	2
Making the Connections	3
Back Panel	3
Right Panel.....	4
Connecting a VGA, Mac Display Monitor or LCD/DLP Projector.....	4
Connecting a TV.....	5
Connecting a Computer	5
Connecting the Power Adapter	6
Inserting and Ejecting a SD Card.....	6
Connecting a Computer via USB Connection	6
Setting Up SPC300	7
Arm	7
Camera Head	7
LED Lamp	7
Infrared Sensor.....	8
LED Power Button.....	8
Microscope Connection.....	8
Anti-glare	8
Using the Infrared Remote Control	9
Touch Button Control Panel	11
Presentation Highlight Functions	12
Timer Function	13
To Set the Timer:.....	13
To View and Start the Timer Countdown:	13
OSD Navigation Tree	14
Menu Functions	15
Using AVerVision SPC300 as a Mass Storage	17
Technical Specifications	17
Image.....	17
Optics	17
Power	17
Lighting.....	17
Input/Output.....	17
Dimension	18
Card Supported	18
RS-232C Diagram Connection	18
RS-232C Cable Spec	18
RS-232C Transmission Spec	18
RS-232C Communication Format	18
RS-232C Command Table	19
Troubleshooting	19
Limited Warranty	20

Introduction

Thank you for purchasing the AVerMedia® AVerVision SPC300. This document camera displays any documents, negatives, transparencies and 3D objects onto a TV, LCD or DLP projector making demonstrations a snap.

The advanced features of the AVerVision SPC300 make it a versatile and multi-functional product. You can save still images with the built-in memory, or SD memory card. When connected to a computer via USB connection and with the bundled software, you can capture and save still images and video clips to your hard drive directly. It also comes with a fully-featured remote control.

Package Contents

Your AVerMedia® AVerVision SPC300 package contains the following:



AVerMedia® AVerVision SPC300



User Manual

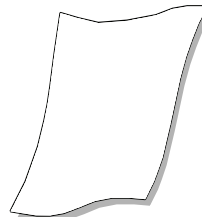

(1) Anti-glare Sheet



Remote Control
(batteries included)

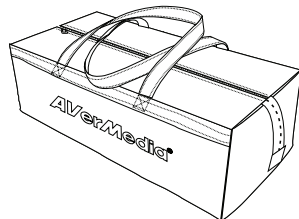

Carrying Bag

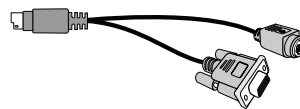

S-Video/RS-232 Cable

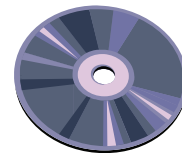

Installation CD

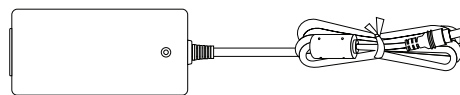

Power Adapter



RCA Cable



S-Video Cable



Power Cord



Computer Extension Cable (VGA Cable)



USB Cable

* The power cord varies depending on the standard power outlet of the country where it is sold.

AVerMedia

AVerMedia® AVerVision SPC300 Parts

The illustrations below identify the parts of SPC300.

1. LED lamp
2. Camera head latch
3. Camera head
4. Camera lens
5. Control panel
6. Left panel
7. Support stand
8. IR sensor
9. Arm
10. Arm latch
11. Label slot
12. Rear panel
13. Antitheft slot
14. RGB input port
15. TV/RGB display switch
16. DC 12V port
17. RGB output port
18. S-Video output port
19. Video output port (RCA/Composite)
20. DVI-I output port
21. USB port
22. SD card slot

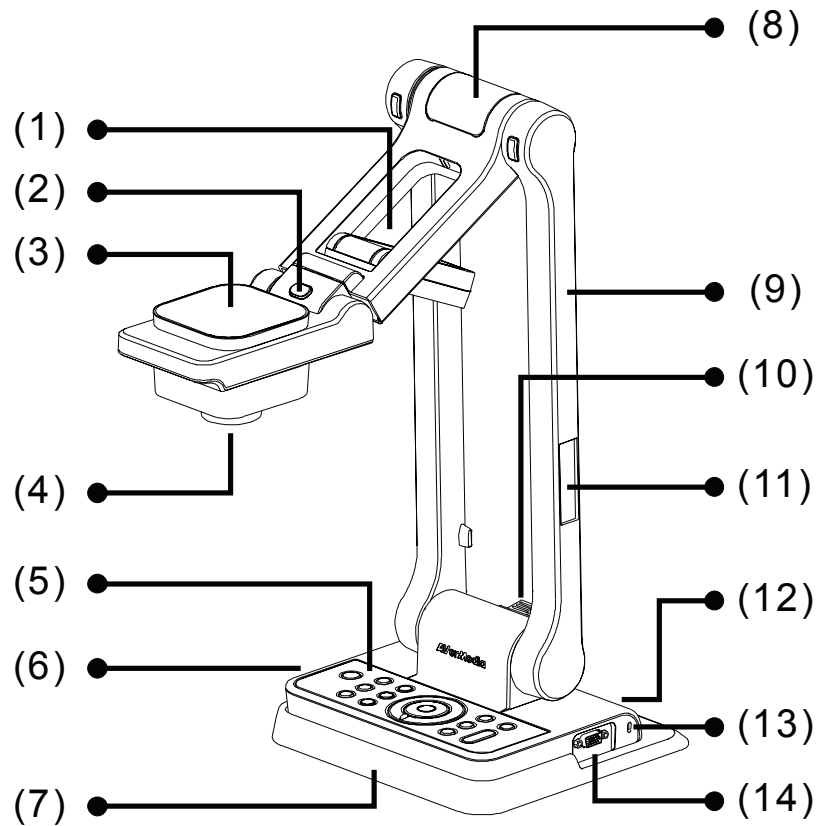

Left Panel

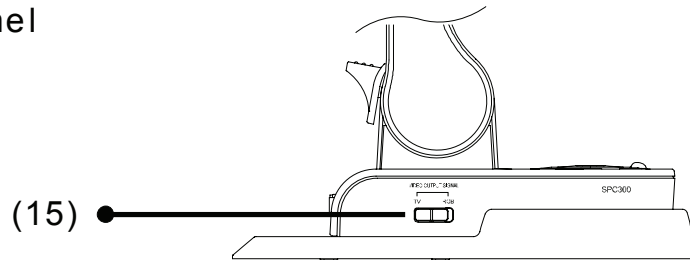

Rear Panel

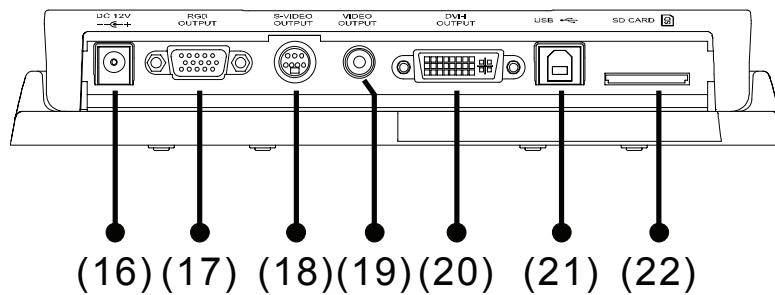

AVerMedia

Making the Connections

The ports at the back and right panel of the SPC300 enable you to connect the unit to a computer, graphics display monitor, LCD/DLP projector, TV or other devices. Illustrated below are the ports located at the back and right panel of the SPC300 with their corresponding labels.

Back Panel

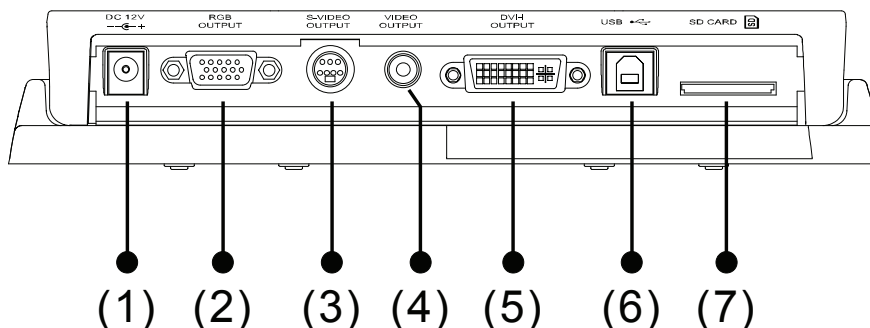

Name	Function
(1) DC 12V port	: Connect the power adapter into this port.
(2) RGB output port	: Output RGB signal from camera, RGB input port, or the captured images from the memory source and preview it on a VGA/Mac monitor or LCD/DLP projector.
(3) S-Video output port	: Output the signal from the camera or the captured images from the memory source on TV or AV equipment. Connecting the S-Video/RS-232 cable allows using a computer to control SPC300 thru RS-232 connection.
(4) Video output port (RCA/Composite)	: Output the signal from the camera or the captured images from the memory source on TV or AV equipment.
(5) DVI-I output port	: Output RGB signal from camera, RGB input port, or the captured images from the memory source and preview it on a LCD/Mac monitor or LCD/DLP projector with DVI-I interface. If the display device does not support DVI-I, it can only display RGB signal from camera and preview captured images.
(6) USB port	: Use SPC300 as a USB Camera or Mass Storage device allowing you to transfer the captured images to and from the SPC300 memory source and PC.
(7) SD card slot	: Insert the SD card with the label facing up. This supports 16~512MB card capacity and only accepts FAT16 formatted card.

Right Panel

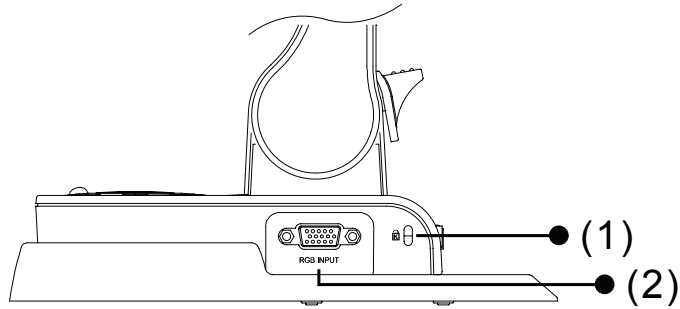

Name	Function
(1) Antitheft slot	: Attach a Kensington compatible security lock or antitheft device.
(2) RGB input port	: Input RGB signal from a computer or other sources and pass it through to the RGB and DVI-I output port only. Connect this port to the RGB output port of the computer.

Connecting a VGA, Mac Display Monitor or LCD/DLP Projector

Locate the RGB (VGA) or DVI-I input port of the display device. If you are not sure, please refer to the user manual of the device.



Make sure the TV/RGB switch is set to RGB.

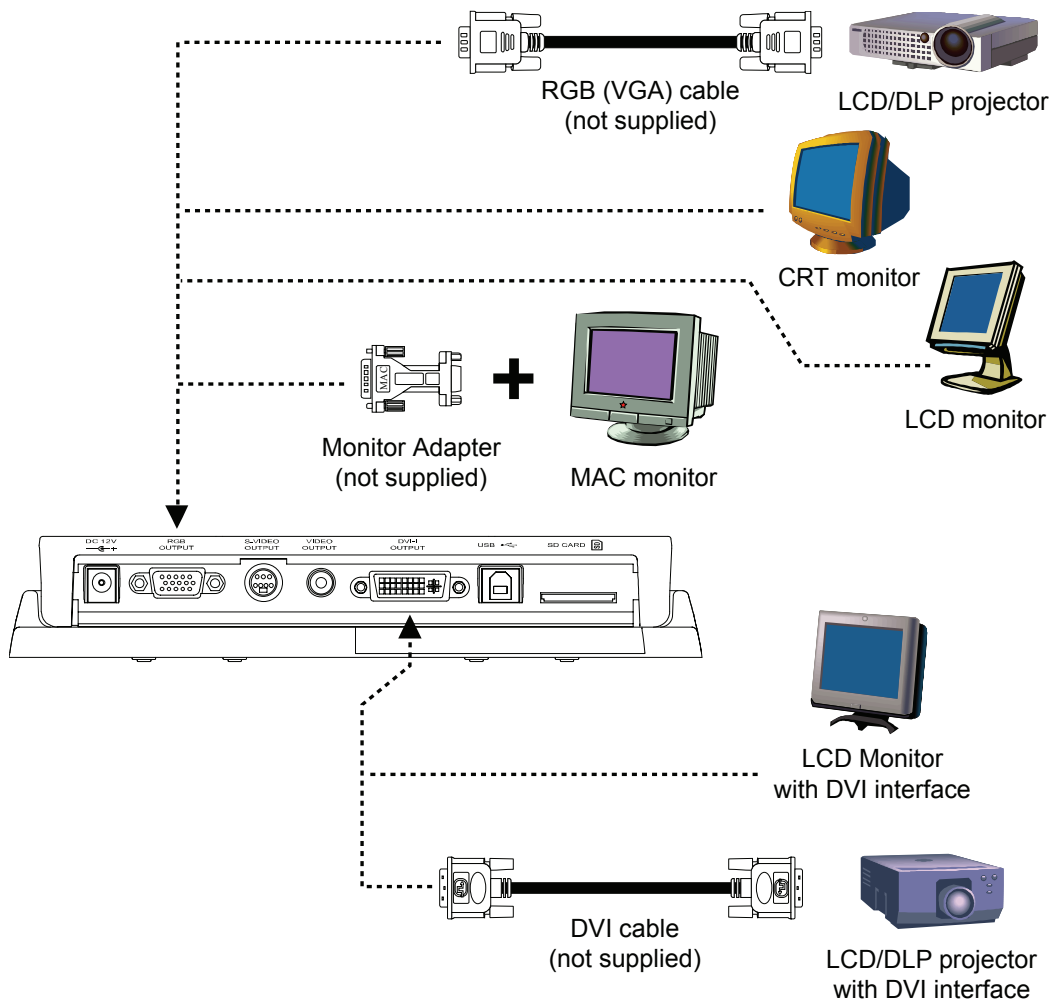

Connecting a TV

Locate the video (yellow), s-video or SCART RGB input port of the TV or AV equipment (i.e., VCR) to record your presentation on a videotape. If you are not sure, please refer to the user manual of the TV or AV equipment.



- Make sure the TV/RGB switch is set to TV.
- For better video quality, we strongly suggest using s-video connection.

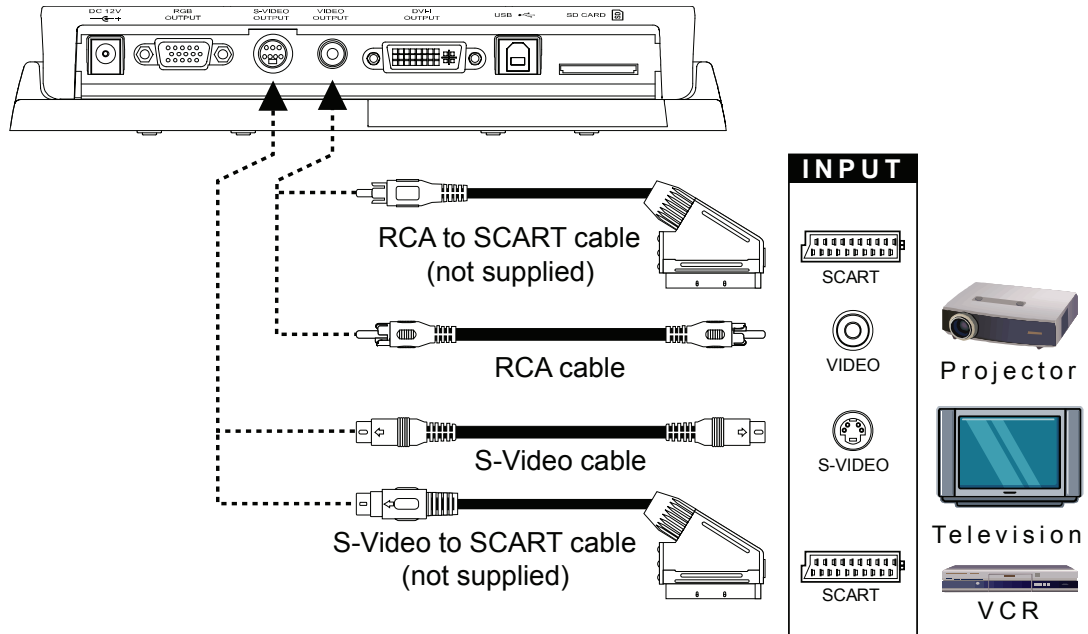

Connecting a Computer

Locate the RGB video output port of the computer or laptop to display your PC presentation on screen. The video signal from the RGB input port is streamed to RGB and DVI-I output port and displayed on screen.

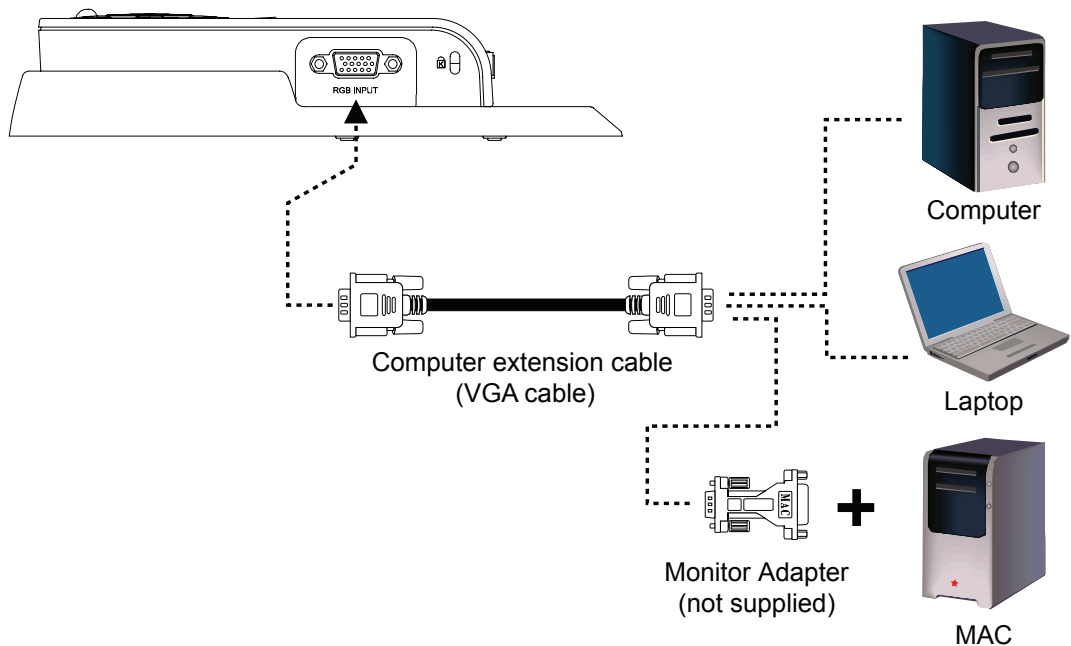

Connecting the Power Adapter

Connect the power adapter to a standard 100V~240V AC power source.

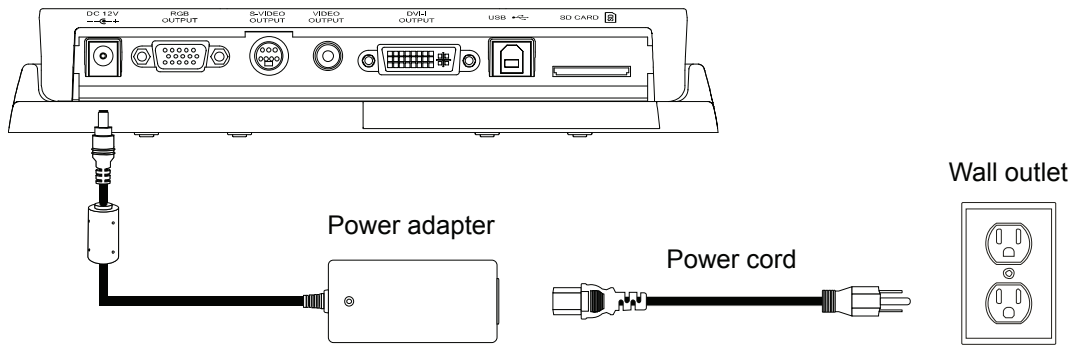

Inserting and Ejecting a SD Card

Insert the card with the label facing up until it reaches the end. To remove, pull the card out. Card slots can support 16~512MB capacity. Make sure the card format is FAT16.

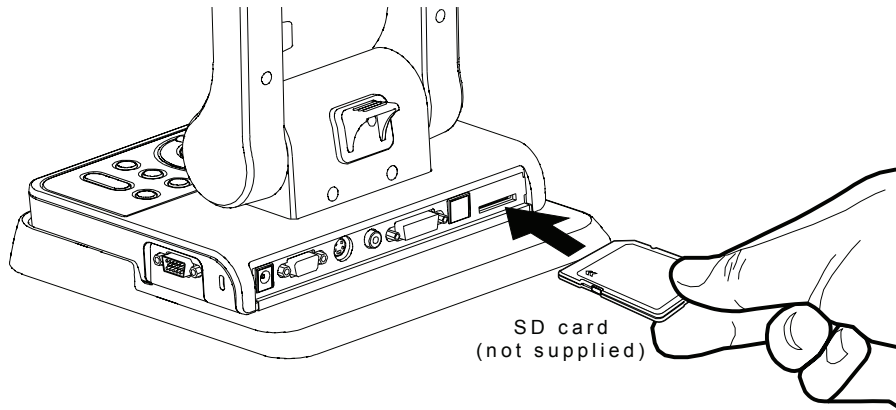

Connecting a Computer via USB Connection

Locate the USB port of the computer or laptop. This enables you to use SPC300 as a USB Camera and Mass Storage to transfer the captured images to and from the memory source and computer. Also see "Using AVerVision SPC300 as a Mass Storage".

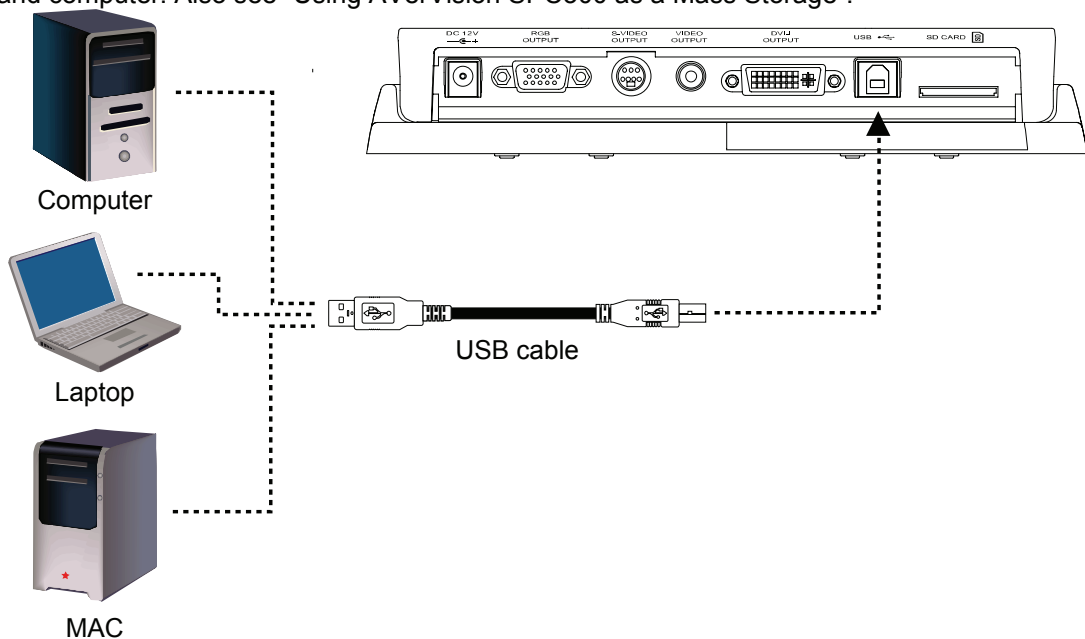

Setting Up SPC300

This section tells how to setup and adjust the SPC300 to meet your needs.

Arm

PUSH the latch before unfolding and folding the arm.

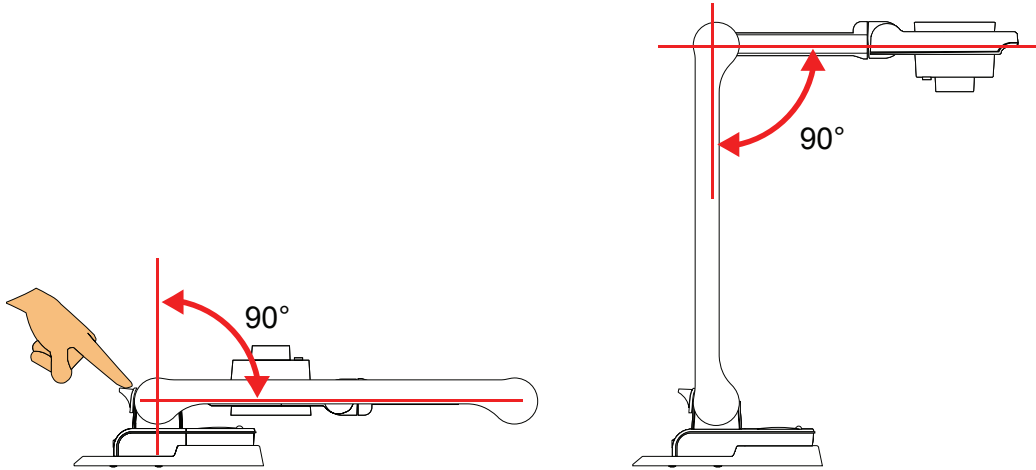

Camera Head

PUSH the latch before folding the camera head.

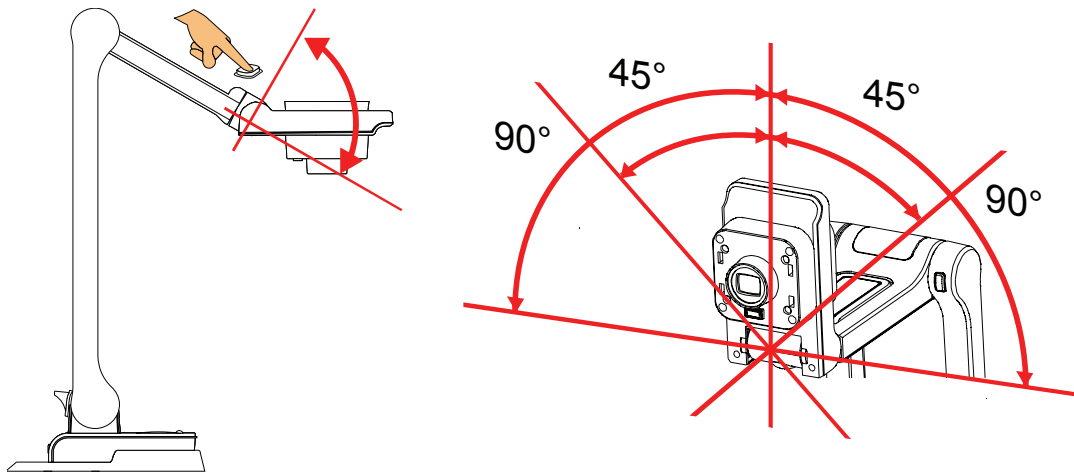

LED Lamp

Press LAMP button on the control panel to turn on and off light.

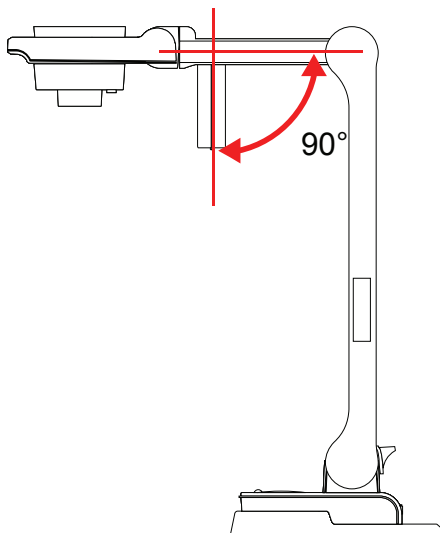

Infrared Sensor

Aim the remote control at the infrared sensor to operate the unit.

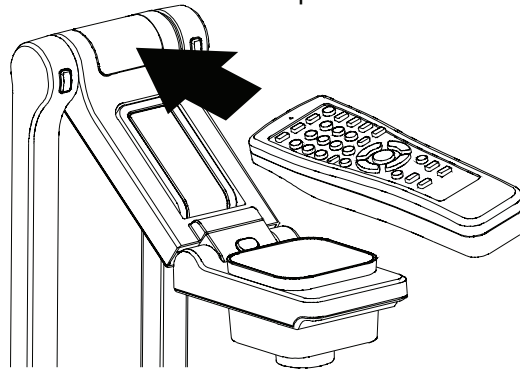

LED Power Button

The LED power button on the control panel of SPC300 indicates the status of the unit.



Color	Description
Blue	: The unit is in standby mode.
Orange	: The unit is in operating mode.

Microscope Connection

Connecting the SPC300 to a microscope enables you to examine microscopic objects on a big screen without straining your eyes. To display microscopic image clearly, press **MENU** > select **THEME > MICROSCOPE** and press **ENTER**.

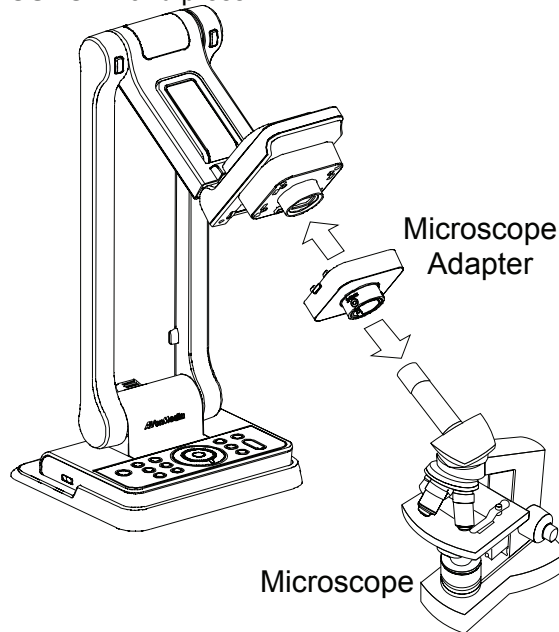

Anti-glare

Place the anti-glare sheet on top of shiny documents to reduce light reflection. The anti-glare sheet is a special coated film that helps eliminate the light reflection when you are displaying a very shiny object or glossy surface such as magazines, etc.

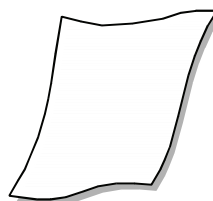

Using the Infrared Remote Control

Use the AVerVision SPC300 Remote Control to enhance your presentation, switch between (3) three presentation modes and access additional features. To use the remote control, first insert the batteries (2 size “AAA” batteries are provided) into the battery compartment at the back of the remote. Use the figure and descriptions below to help you use the remote control.

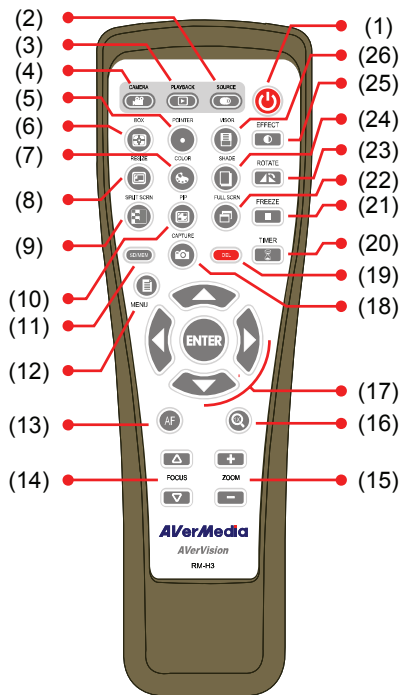

















Name	Button	Function
(1) POWER		Turn the unit on/off.
(2) SOURCE		Display the video signal from the RGB input port.
(3) PLAYBACK MODE		Display the captured image either from the built-in memory or SD card in 16-thumbnail preview. Use the ▲, ▼, ◀, & ▶ buttons to make a selection and ENTER to display the selected image in full screen.

In Playback Mode, press **MENU** to access the ff:

- **SLIDE SHOW** - start to automatically display from the selected image to the next one and repeatedly display all the images in a loop.
To pause or resume slide show, press **ENTER**.
To manually move to the previous or next image, press ◀ or ▶.
- **MEMORY SOURCE** - select the image source between the built-in memory or SD card.
- **DELETE** - permanently remove the selected image.

Name	Button	Function
(4) CAMERA MODE		Display the image from the SPC300 built-in CMOS camera.
(5) POINTER		Toggle to show or hide a dot like a laser pointer on the screen in camera mode. To move the pointer, use the ▲, ▼, ◀, & ▶ buttons.
(6) BOX		Toggle to show or hide the frame on the screen in camera mode. To move the box, use the ▲, ▼, ◀, & ▶ buttons.
(7) COLOR		Select the color of the Pointer and Box. There are 15 available colors to choose from.
(8) RESIZE		Enable to change the size of the box. When the frame blinks, use the ▲, ▼, ◀, & ▶ buttons to change the frame size and then press ENTER .
(9) SPLIT SCREEN		Divide the screen into two parts. The Right side displays the live image from the SPC300 camera and the left side displays the captured images from the memory source in 8-thumbnail preview. Use the ▲, ▼, ◀, & ▶ buttons to make a selection and ENTER to enlarge the selected image in split screen mode. To horizontally pan the enlarged image, use the ◀ & ▶ buttons. To increase or decrease the live image from the SPC camera on the right side display, use the zoom +/-.

Name	Button	Function
(10) PIP		Display a thumbnail of the captured image from the memory source at the corner of the screen while in camera mode. Use the ◀ or ▶ buttons to move to the previous or next image. To move the thumbnail mini preview screen to different corners, press the PIP button again. To increase or decrease the live image from the SPC camera, use the zoom +/-.
(11) SD/MEM		Select the memory source between SD card or built-in memory.
(12) MENU		Pull up and exit the OSD main-menu and sub-menu.
(13) AF		Automatically adjust the focus.
(14) FOCUS ▲ / ▼		Adjust the focus manually.
(15) ZOOM +/-		<ul style="list-style-type: none"> - Zoom in and out the image 8X digitally in Playback and Box mode. - Zoom in and out the image optically and digitally in Camera mode.
 The image may appear blurry when optically zooming the image in and out. After achieving the desired magnification, the camera automatically adjusts the focus and the image will become clear again.		
(16) ZOOM RESET		Return to normal view (1x).
(17) ▲, ▼, ◀, ▶, & ENTER		Use these buttons in Playback, Box, Pointer, Visor, Resize, Split Screen, PIP function, and Menu to make a selection and adjustment (See Menu Functions, for more details).
(18) CAPTURE		Capture a still image. The captured image is saved in the memory source at 1024 x 768 resolution.
(19) DELETE		Remove the selected picture permanently in Playback mode.
(20) TIMER		Display, start and hide the on-screen display timer. The timer display can be toggled to show or hide when the timer countdown has started (See Timer Function for more details). To reset the timer, press and hold down TIMER button.
(21) FREEZE		Toggle to pause and resume the image from SPC300 built-in CMOS camera.
(22) FULL SCREEN		View the selected thumbnail captured image on the entire screen in Playback, Split Screen or PIP mode.
(23) ROTATE		Turn the image by 90° each time this button is pressed in camera mode.
(24) SHADE		<ul style="list-style-type: none"> - Change the covered area of the Visor to semi-transparent or opaque. - Change the outer side of the Box to semi-transparent, opaque, or transparent.

Name	Button	Function
(25) EFFECT		Convert and display the image into BW, Negative or Color when in Camera and Playback single preview mode.
(26) VISOR		Toggle to cover or uncover a part of the screen in camera mode. Use the ▲, ▼, ◀, & ▶ buttons to reveal the covered part.

Touch Button Control Panel

The touch button control panel located on the top side of AVerVision SPC300 provides quick access to commonly used functions.

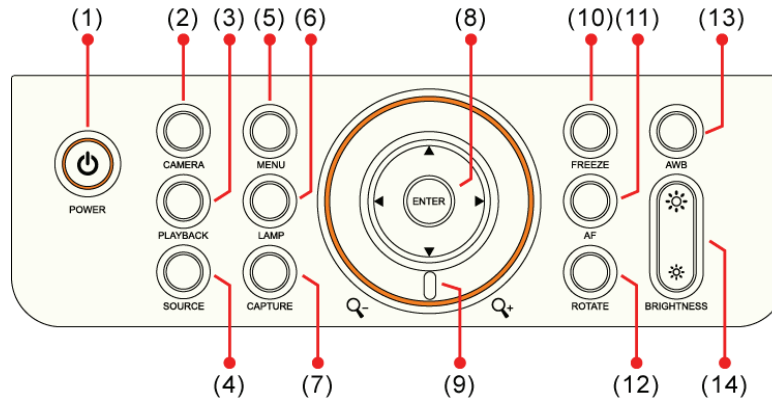

Name	Function
(1) POWER	Turn the unit on/off.
(2) CAMERA MODE	Display the image from the SPC300 built-in CMOS camera.
(3) PLAYBACK MODE	Display the captured image either from the built-in memory or SD card in 16-thumbnail preview. Use the ▲, ▼, ◀, & ▶ buttons to make a selection and ENTER to display the selected image in full screen.
In Playback Mode, press MENU to access the ff:	
• SLIDE SHOW	- start to automatically display from the selected image to the next one and repeatedly display all the images in a loop. To pause or resume slide show, press ENTER . To manually move to the previous or next image, press ◀ or ▶.
• MEMORY SOURCE	- select the image source between the built-in memory or SD card.
• DELETE	- permanently remove the selected image.
(4) SOURCE	Display the video signal from the RGB input port.
(5) MENU	Pull up and exit the OSD main-menu and sub-menu.
(6) LAMP	Turn the LED light on or off.
(7) CAPTURE	Capture a still image. The captured image is saved in the memory source at 1024 x 768 resolution.
(8) ▲, ▼, ◀, ▶, & ENTER	Use these buttons in Playback, Box, Pointer, Visor, Resize, Split Screen, PIP function, and Menu to make a selection and adjustment (See Menu Functions, for more details).
(9) ZOOM SHUTTLE	- Zoom in and out the image 8X digitally in Playback and Box mode. - Zoom in and out the image optically and digitally in Camera mode.
(10) FREEZE	Toggle to pause and resume the image from SPC300 built-in CMOS camera.
(11) AF	Automatically adjust the focus.
(12) ROTATE	Turn the image by 90° each time this button is pressed in camera mode.

Name	Function
(13) AWB	Lock/unlock Auto White Balance (AWB).
	The camera constantly looks at the overall color of the image and calculates the best-fit white balance. Each time when the layout of the captured image changes the color shifts. To lock the reference point which represent the white, place a piece of white paper, adjust till it fills the screen then press AWB and wait till "AWB LOCK" appear on the screen. To set to AWB AUTO, press the button again.
(12) Brightness	Adjust the brightness level in camera mode.

Presentation Highlight Functions

The SPC300 provides 3 special functions for highlighting key points in any presentation: Box, Pointer and Visor. You can use these functions by pressing the corresponding buttons on the remote control.

Box

A colored frame which allows your viewer to focus on a particular subject in your presentation.

To change the color of the box, press **COLOR** button repeatedly and select your desired color. There are 15 available colors to choose from.

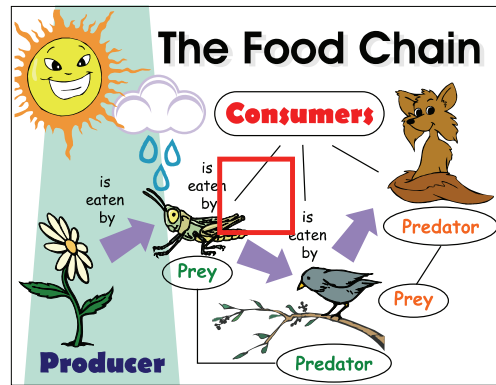

To change the size of the box, press **RESIZE** when the frame blinks, use the **▲, ▼, ◀, & ▶** buttons to change the frame size and then press **ENTER**.

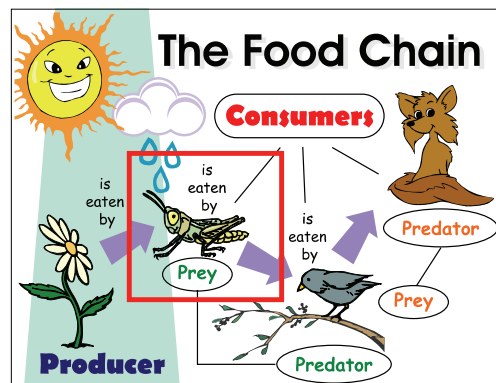

To make it look like a spotlight and darken the rest of the image, press **SHADE**. This changes the shaded area to semi-transparent, opaque, and transparent.

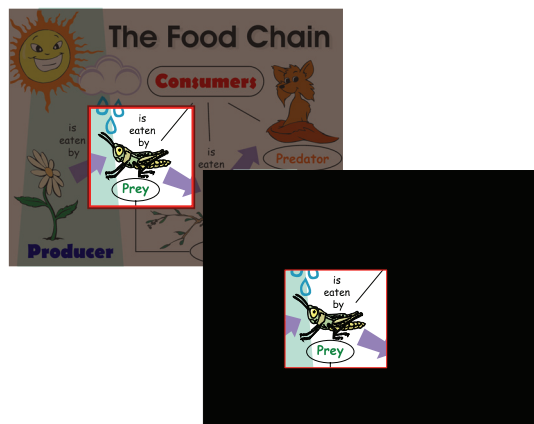

Pointer

A dot like a laser pointer which direct your viewer's attention to key areas in your presentation.

To move the pointer, use the ▲, ▼, ◀, & ▶ buttons.

To change the color of the pointer, press **COLOR** button repeatedly and select your desired color. There are 15 available colors to choose from.

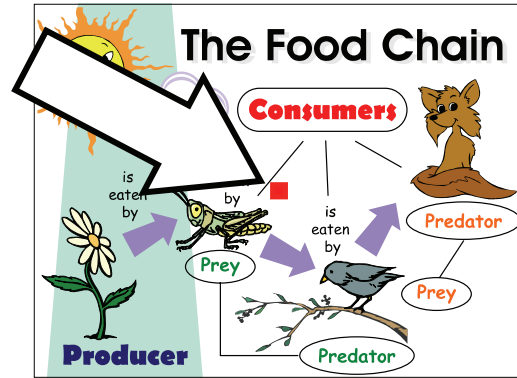

Visor

This highlight a part of your presentation and then "cover" the rest by darkening areas which you do not want to show to your audience.

When you press the **VISOR** button for the first time, the upper part of your presentation screen will be highlighted.

To show or darken more parts of your presentation screen, use the ▲, ▼, ◀, & ▶ buttons.

To changes the shaded area from opaque to semi-transparent, press **SHADE**.

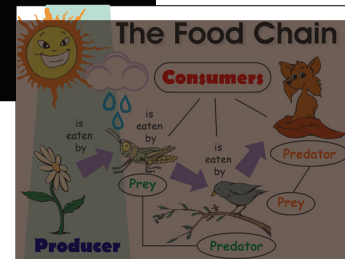
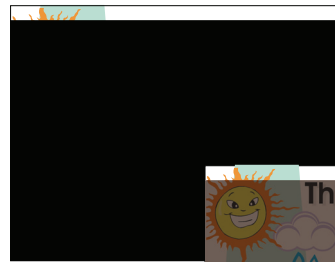





Timer Function

The AVerVision SPC300 enables you to control the pace of your presentation by displaying the remaining time on the countdown screen. This merely serves as a reminder. When the time is up, the timer blinks at the top right corner of the screen and the presentation screen will not be affected in any way.

To Set the Timer:

1. Press **MENU** and select **SETTING** tab.
2. Press ▲ or ▼ buttons to select **TIMER > PRESENTATION**.
3. Press ▶ or ◀ buttons to set a time value. You can set the time value up to 120 minutes.
4. After setting the time value, press the **MENU** button to go back to the main menu and exit.

To View and Start the Timer Countdown:

1. To display the previously set time value, press  once. The AVerVision SPC300 automatically converts your settings to "hours:minutes:seconds" format.
2. To start the countdown, press  again.
3. Once the countdown timer starts, you can toggle the countdown screen to display and hide it by pressing . To reset timer countdown, press hold  for about about 3 seconds.

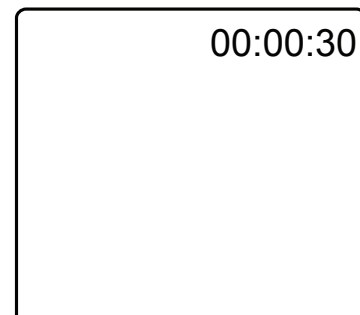

OSD Navigation Tree

VIDEO OUTPUT OSD



For TV output, RESOLUTION is not included in the menu list.

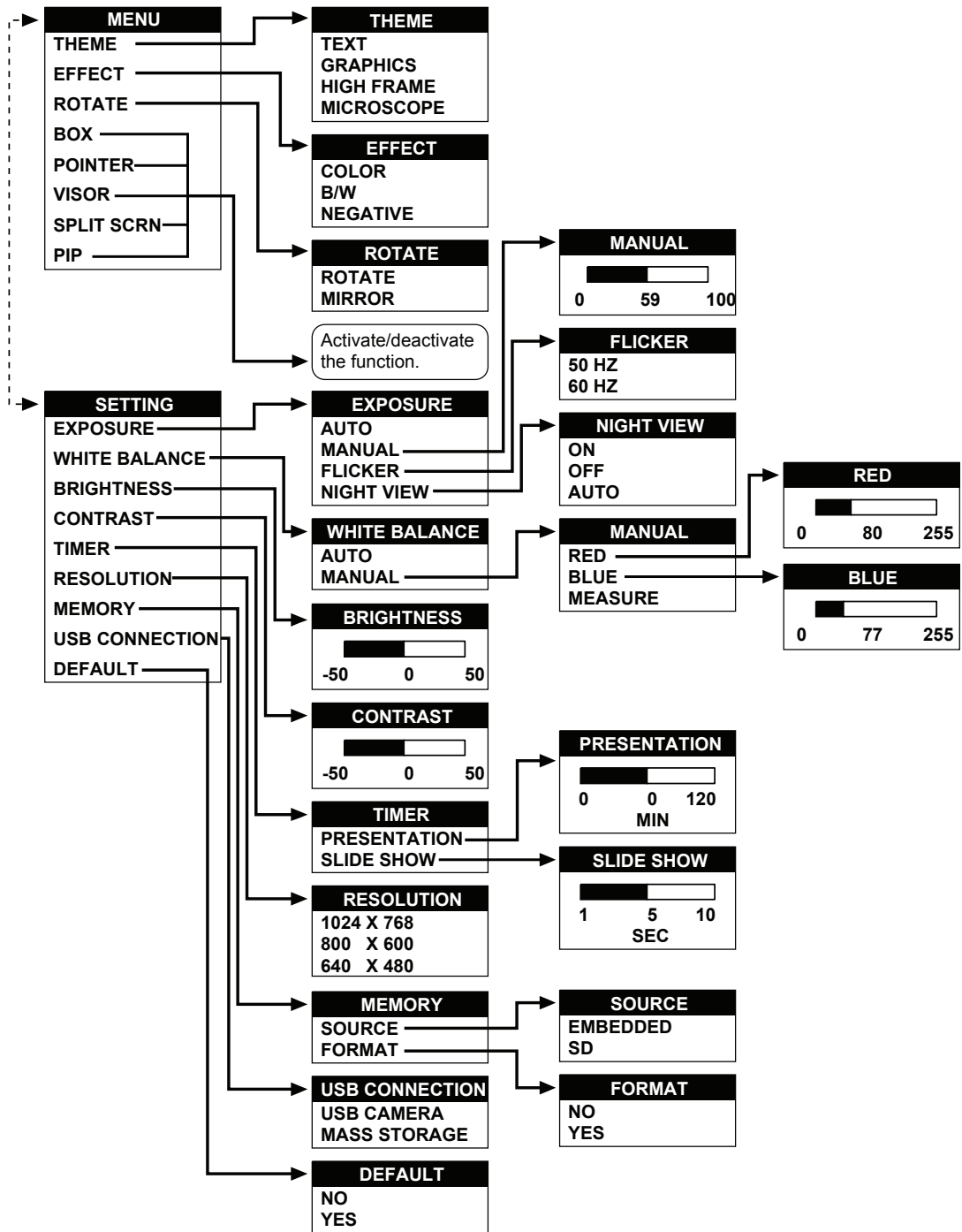

PLAYBACK OSD

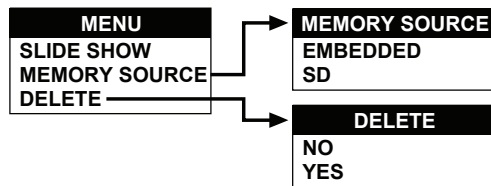

Menu Functions

The SPC300 provides MENU functions enabling you to fine-tune your screen display, set the timer, and more. Press the **MENU** button to call up and exit from the main menu or sub-menu display. Then use **▲** or **▼** buttons to select the items in the menu list. Use **ENTER** button to enter sub-menu. To adjust the setting, press **◀** or **▶** buttons.

OSD Menu	Description
THEME TEXT GRAPHICS HIGH FRAME MICROSCOPE	THEME : Use ▲ or ▼ buttons to select between Text, Graphics, High Frame or Microscope image enhancement mode. <ul style="list-style-type: none"> • Text - corrects the intensity of the adjacent pixel making it more uniform producing sharper and clearer images. • Graphics - adjusts the gradient of the adjacent pixel making it appears to have a smooth image. • High Frame - increases the frame rate capture and can visually tracks the motion and react quickly. Sufficient lighting is required when using this mode. • Microscope - automatically fixes the optical zoom and displays the microscope image more clearly.
EFFECT COLOR B/W NEGATIVE	EFFECT : Use ▲ or ▼ buttons and select to display the image from the SPC300 camera into positive (true color), monochrome (black and white), or negative.
ROTATE ROTATE MIRROR	ROTATE : Use ▲ or ▼ buttons and select to flip or rotate the image by 90° from the SPC300 camera.
EXPOSURE AUTO MANUAL FLICKER NIGHT VIEW	EXPOSURE : Use ▲ or ▼ buttons to select between Auto and Manual. SPC300 enables you to automatically or manually adjust the camera to determine how much light is required.
MANUAL 	If you choose to manually adjust the exposure, press ▶ or ◀ buttons to adjust the exposure level.
FLICKER 50 HZ 60 HZ	FLICKER : Use ▲ or ▼ buttons to select between 50Hz or 60Hz. Some display devices cannot handle high refresh rates. The image will flicker a couple of times as the output is switched to another refresh rate.
NIGHT VIEW ON OFF AUTO	NIGHT VIEW : Use ▲ or ▼ buttons to select enable/disable night view or detect to automatically turn on/off night view. If you are presenting in a low-light condition, Night View enables the image of the object to appear as though under normal lighting condition. The SPC300 automatically adjusts the exposure to compensate for the adverse condition, but the captured image will appear to be in low frame rate.
WHITE BALANCE AUTO MANUAL	WHITE BALANCE : Use ▲ or ▼ buttons to select between Auto and Manual. SPC300 enables you to automatically or manually adjust the camera to suit the lighting condition or color temperature. If you select to manually adjust the white balance, you can adjust the Red, Blue or use the system to measure the color temperature.
MANUAL RED BLUE MEASURE	To obtain a more accurate color balance, place a sheet of white paper under the camera. Select MEASURE then press ENTER to calibrate the color temperature. Wait until the " AWB LOCK " appears at the lower right corner of the presentation screen.

OSD Menu	Description
BRIGHTNESS 	BRIGHTNESS : Press ► or ◀ buttons to increase or decrease the brightness level and improve the visibility of the image. The brightness level can be set up to ±50.
CONTRAST 	CONTRAST : Press ► or ◀ buttons to emphasize or reduce the difference between light and dark conditions. The contrast level can be adjustable up to ±50.
TIMER PRESENTATION SLIDE SHOW	TIMER : Use ▲ or ▼ buttons to select presetting the presentation timer or slide show time interval.
PRESENTATION 	PRESENTATION : Press ► or ◀ buttons to set a time value. The presentation timer value can be set up to 120 minutes (See Timer Function for more details).
SLIDE SHOW 	SLIDE SHOW : Press ► or ◀ buttons to set a time interval value. The slide show time interval can be set up to 10 seconds.
RESOLUTION 1024 X 768 800 X 600 640 X 480	RESOLUTION : Use ▲ or ▼ buttons to choose from 1024x768, 800x600 or 640x480 display resolution then press ENTER to make the selection. This is available only for RGB and DVI-I video output.
MEMORY SOURCE FORMAT	MEMORY : Use ▲ or ▼ buttons to select the memory source on where to store or view the image.
SOURCE EMBEDDED SD	SOURCE : Use ▲ or ▼ buttons to select the memory source either from the SPC300 built-in memory (embedded) or SD card.
FORMAT NO YES	FORMAT : Use ▲ or ▼ to select NO to exit or YES to format and delete all the data in the memory source then press ENTER. The message "FORMAT" will appear then the process is finished.
USB CONNECTION USB CAMERA MASS STORAGE	USB SELECT : Use ▲ or ▼ buttons to select the USB function between USB Camera or Mass Storage. <ul style="list-style-type: none"> • USB Camera - can be used as a computer webcam or with our bundled software as video recorder and capture still image. • Mass Storage - transfer the captured images to and from the memory source and computer hard disk.
DEFAULT NO YES	DEFAULT : Use ▲ or ▼ buttons to select YES to restore to original factory default setting or NO to keep the current setting.
MENU SLIDE SHOW MEMORY SOURCE DELETE	PLAYBACK MENU : Press MENU when you are in Playback mode then use the ▲ or ▼ buttons to make a selection. <ul style="list-style-type: none"> • Slide Show - automatically display all the pictures one at a time. • Memory Source - select the image source between the built-in memory or SD card. • Delete - permanently remove the selected picture.

Using AVerVision SPC300 as a Mass Storage

This enables you to transfer the captured image to and from the memory source and PC.



You **MUST** read and follow the instructions below **BEFORE** connecting the USB cable.

Every time when using the SPC300 as Mass Storage, the following **MUST** be done:

1. Select the memory source.

To select the memory source, press **MENU** > select **SETTING** > **MEMORY** > **SOURCE** > **EMBEDDED** or **SD** and press **ENTER**; then press **MENU** to exit.

2. **MUST** set the USB CONNECTION as MASS STORAGE.

To select the USB connection type, press **MENU** > select **SETTING** > **USB CONNECTION** > **MASS STORAGE** and press **ENTER**; then press **MENU** to exit.

3. When "STORAGE" appears at the lower left corner of the presentation screen, you may now connect the USB cable (See "Connecting to Computer thru USB Connection" for illustration).
4. Upon connecting the USB cable, the system automatically detects the new removable disk.
5. In the Removable Disk dialog box, select **Open folder to view files** and then click **OK**. You may now transfer the file to and from your PC hard disk.

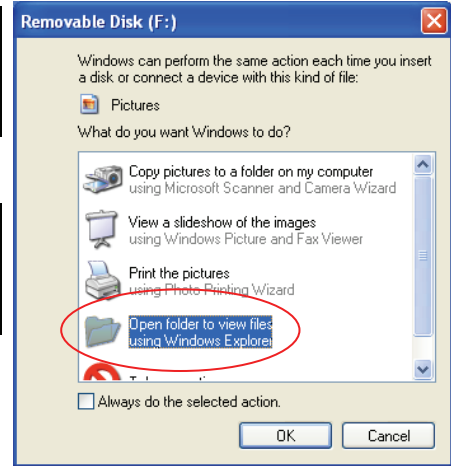

Technical Specifications

Image

Sensor	1/2" CMOS color image sensor
Total Pixel Count	3.2 mega pixels
Frame Rate	24 fps (max)
White Balance	Auto / Manual
Exposure	Auto / Manual / Flicker / Night View
Theme	Text / Graphics / High Frame / Microscope
Effect	Color / BW / Negative / Rotate / Mirror
Analog RGB Output	XGA, SVGA, VGA (60 Hz)
S-Video, Composite Video Output	NTSC or PAL
Image Capture	Up to 80 Frames
Built-In Memory	32MB NAND Flash Memory

Optics

Lens	F=7.3-21.9mm; Auto Focus
Shooting Area	380mm x 280mm (max.)
Zooming	Optical 3x; AVERZOOM 2X, Digital: 8x

Power

Power Source	AC/DC100-240V ~ 4A, 50-60 Hz
Consumption	9.5 Watts (light on); 7 Watts (light off)

Lighting

Lamp Type	LED Lamp
-----------	----------

Input/Output

RGB Input	15-Pins D-sub (VGA)
RGB Output	15-Pins D-sub (VGA)
DVI-I Output	DVI-I Type
S-Video Output	Mini-DIN Jack
Video Output	RCA Jack
USB	USB2.0

Dimension

Fully Unfolded	229mm x 429mm x 488mm (9" x 16.9" x 19.2")
Folded	229mm x 508mm x 140mm (9" x 20" x 5.5")
Weight	4kg (about 8.8 lb) with mounting base

Card Supported

Secure Digital (SD)	16~512MB
---------------------	----------

RS-232C Diagram Connection

SPC300 can be controlled using a PC through RS-232 connection.

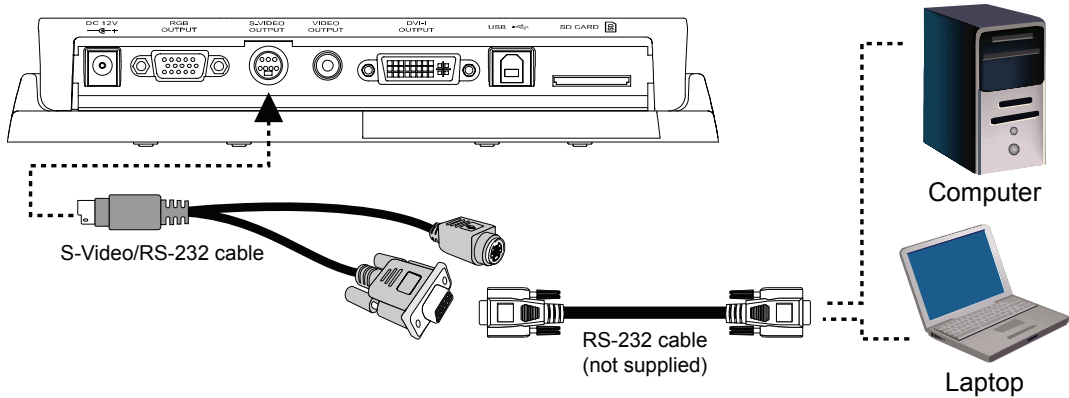

RS-232C Cable Spec

Make sure the RS-232 cable matches the cable spec design.

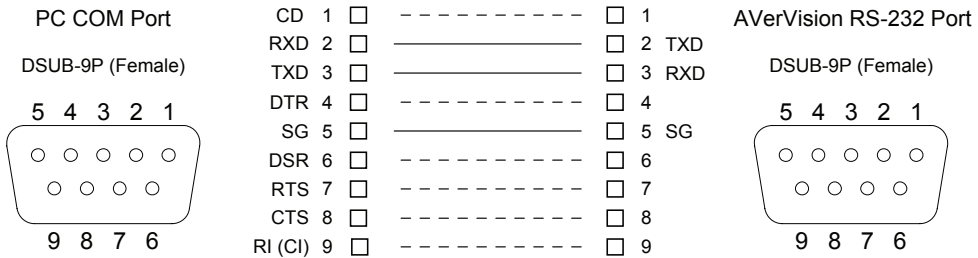

RS-232C Transmission Spec

- Star bit : 1 bit
- Data bit : 8 bit
- Stop bit : 1 bit
- Parity bit : None
- X parameter : None
- Baud rate(Communication speed) : 9600bds

RS-232C Communication Format

Start Code (1 Byte) : 0x52

Type Code (1 Byte) : 0x05

DataLength Code (1 Byte) : 0x01

Data Code (1 Byte) : Please see the Command Table for the reference.

End Code (1 Byte) : 0x53

CheckSum Code(1 Byte) : Please see the Command Table for the reference.

Format : Start + Type + DataLength + Data + End + CheckSum

Example : 0x52 + 0x05 + 0x01 + 0x80 + 0x53 + 0xD7 (Command Power ON/OFF)

RS-232C Command Table

FUNCTION	DATA CODE	CHECKSUM CODE
AWC	0x76	0x21
AF	0x97	0xC0
LAMP ON/OFF	0x75	0x22
POWER ON/OFF	0x80	0xD7
ROTATE	0x88	0xDF
CAMERA MODE	0xC0	0x97
PLAYBACK MODE	0xC1	0x96
SOURCE	0xC2	0x95
BOX ON/OFF	0x81	0xD6
VISOR ON/OFF	0x83	0xD4
POINTER ON/OFF	0x82	0xD5
COLOR	0x86	0xD1
RESIZE	0x85	0xD2
SHADE	0x87	0xD0
SPLT SCRN	0x89	0xDE
PIP	0x8A	0xDD
FULL SCREEN	0x8B	0xDC
SD/MEM	0x8D	0xDA
CAPTURE	0x8E	0xD9
DELETE	0x8F	0xD8
EFFECT	0x84	0xD3
FREEZE	0x8C	0xDB
MENU	0x91	0xC6
UP	0x92	0xC5
DOWN	0x96	0xC1
RIGHT	0x95	0xC2
LEFT	0x93	0xC4
ENTER	0x94	0xC3
ZOOM RESET	0x98	0xCF
NEAR	0x9B	0xCC
FAR	0x99	0xCE
ZOOM IN	0x9A	0xCD
ZOOM OUT	0x9C	0xCB
BRT UP	0x72	0x25

Troubleshooting

This section provides useful tips describing how to solve common problems while using the AVerVision SPC300.

There is no picture on the presentation screen.

1. Check all the connectors again as illustrated in this manual.
 2. Check the remote control's on/off switch on your display output device.
 3. Verify the setting of the display output device.
 4. If you are using a notebook or computer, you may have to switch the source to VGA.
 5. Make sure the TV/RGB switch is properly set based on your display output.
-

There is no computer signal on the presentation screen.

When you turn on the computer, it will auto-detect the type of monitor you have. During auto-detection, there won't be any display on your presentation screen. To avoid this problem, connect your computer and all the necessary cables to the AVerVision SPC300 first before you power on your computer.

Limited Warranty

For a period of time beginning on the date of purchase of the applicable product and extending as set forth in Section 6 of this Limited Warranty (the "Warranty Period"), AVerMedia Technologies, Inc. ("AVerMedia") warrants that the applicable product ("Product") substantially conforms to AVerMedia's documentation for the product and that its manufacture and components are free of defects in material and workmanship under normal use. "You" as used in this agreement means you individually or the business entity on whose behalf you use or install the product, as applicable. This limited warranty extends only to You as the original purchaser. Except for the foregoing, the Product is provided "AS IS." In no event does AVerMedia warrant that You will be able to operate the Product without problems or interruptions, or that the Product is suitable for your purposes. Your exclusive remedy and the entire liability of AVerMedia under this paragraph shall be, at AVerMedia's option, the repair or replacement of the Product with the same or a comparable product. This warranty does not apply to (a) any Product on which the serial number has been defaced, modified, or removed, or (b) cartons, cases, batteries, cabinets, tapes, or accessories used with this product. This warranty does not apply to any Product that has suffered damage, deterioration or malfunction due to (a) accident, abuse, misuse, neglect, fire, water, lightning, or other acts of nature, commercial or industrial use, unauthorized product modification or failure to follow instructions included with the Product, (b) misapplication of service by someone other than the manufacturer's representative, (c) any shipment damages (such claims must be made with the carrier), or (d) any other causes that do not relate to a Product defect. The Warranty Period of any repaired or replaced Product shall be the longer of (a) the original Warranty Period or (b) thirty (30) days from the date of delivery of the repaired or replaced product.

Limitations of Warranty

AVerMedia makes no warranties to any third party. You are responsible for all claims, damages, settlements, expenses, and attorneys' fees with respect to claims made against You as a result of Your use or misuse of the Product. This warranty applies only if the Product is installed, operated, maintained, and used in accordance with AVerMedia specifications. Specifically, the warranties do not extend to any failure caused by (i) accident, unusual physical, electrical, or electromagnetic stress, neglect or misuse, (ii) fluctuations in electrical power beyond AVerMedia specifications, (iii) use of the Product with any accessories or options not furnished by AVerMedia or its authorized agents, or (iv) installation, alteration, or repair of the Product by anyone other than AVerMedia or its authorized agents.

Disclaimer of Warranty

EXCEPT AS EXPRESSLY PROVIDED OTHERWISE HEREIN AND TO THE MAXIMUM EXTENT PERMITTED BY APPLICABLE LAW, AVERMEDIA DISCLAIMS ALL OTHER WARRANTIES WITH RESPECT TO THE PRODUCT, WHETHER EXPRESS, IMPLIED, STATUTORY OR OTHERWISE, INCLUDING WITHOUT LIMITATION, SATISFACTORY QUALITY, COURSE OF DEALING, TRADE USAGE OR PRACTICE OR THE IMPLIED WARRANTIES OF MERCHANTABILITY, FITNESS FOR A PARTICULAR PURPOSE OR NONINFRINGEMENT OF THIRD PARTY RIGHTS.

Limitation of Liability

IN NO EVENT SHALL AVERMEDIA BE LIABLE FOR INDIRECT, INCIDENTAL, SPECIAL, EXEMPLARY, PUNITIVE, OR CONSEQUENTIAL DAMAGES OF ANY NATURE INCLUDING, BUT NOT LIMITED TO, LOSS OF PROFITS, DATA, REVENUE, PRODUCTION, OR USE, BUSINESS INTERRUPTION, OR PROCUREMENT OF SUBSTITUTE GOODS OR SERVICES ARISING OUT OF OR IN CONNECTION WITH THIS LIMITED WARRANTY, OR THE USE OR PERFORMANCE OF ANY PRODUCT, WHETHER BASED ON CONTRACT OR TORT, INCLUDING NEGLIGENCE, OR ANY OTHER LEGAL THEORY, EVEN IF AVERMEDIA HAS ADVISED OF THE POSSIBILITY OF SUCH DAMAGES. AVERMEDIA'S TOTAL, AGGREGATE LIABILITY FOR DAMAGES OF ANY NATURE, REGARDLESS OF FORM OF ACTION, SHALL IN NO EVENT EXCEED THE AMOUNT PAID BY YOU TO AVERMEDIA FOR THE SPECIFIC PRODUCT UPON WHICH LIABILITY IS BASED.

Governing Law and Your Rights

This warranty gives You specific legal rights; You may also have other rights granted under state law. These rights vary from state to state.



For warranty period, please refer to the warranty card.
