

**QUALITY FEATURES FOR BETTER PICTURES,
EASIER OPERATION, LONGER LIFE**

- Exclusive Camlok® Roller System
- Attractively styled
- Easily installed
- Economically priced
- Completely self-storing
- Ideal for houses of worship, schools, family centers and industrial training rooms.

For the finest in film and video projection

**DA-LITE IS MORE
THAN PROJECTION SCREENS**

Da-Lite Tripod, Wall and
Ceiling and Electric Screens

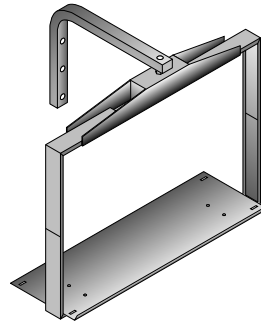
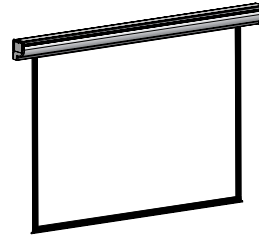

Da-Lite
Monitor Mounts

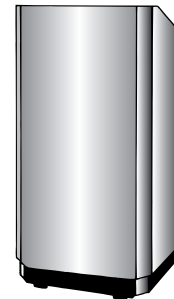

Da-Lite Lecterns



Da-Lite
Project-O-Stands
and Easels

The
POWER *In* _____
PRESENTATION PRODUCTS



DA-LITE

**Operating Instructions
for
MODEL B® WITH CSR
(CONTROLLED
SCREEN RETURN)**

DA-LITE SCREEN COMPANY, INC.
3100 North Detroit Street
Post Office Box 137
Warsaw, Indiana 46581-0137
Phone: 574-267-8101
800-622-3737
Fax: 574-267-7804
Toll Free Fax: 877-325-4832
www.da-lite.com
e-mail: info@da-lite.com

YOU HAVE MADE A WISE SELECTION...

in choosing a Da-Lite projection screen designed and engineered to produce the sharpest, most pleasing pictures with maximum convenience.

PROTECT YOUR SCREEN by keeping it rolled in its protective case when not in use. Always examine both front and back of surface before re-rolling into case to make certain screen is free of dust, dirt or other foreign matter. Use a very soft duster to gently remove any foreign particles.

INSTALLATION

Care in mounting and care in correct operation will mean a long and satisfactory life for your Da-Lite wall/ceiling screen. Locate the screen where the audience can best see it and where other furnishings in the room permit. Mount the screen so that bottom of picture surface, when fully extended, will be above the heads of viewers.

BUILT-IN HANGERS

Da-Lite wall/ceiling screens may be mounted on a wall, map rail, suspended from ceiling or extension brackets. Wall screens must be mounted level and with the case-back parallel to the wall.

FOR WALL MOUNTING –

Use the keyhole slot at the back of the hanging bracket for flush wall suspension. Position screws or other fasteners into the wall and hang screen by using the slots.

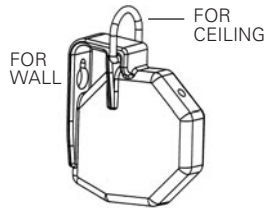

FOR MAP RAIL MOUNTING –

Use keyhole slots in flat brackets. Do not use "D" rings.

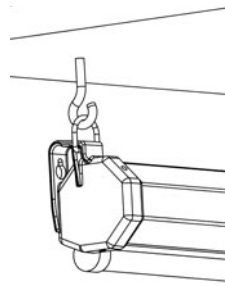

FOR CEILING SUSPENSION

If the screen is to be ceiling mounted, two screw hooks should be placed in a beam or other solid surface. For drop ceilings, Da-Lite's T-Bar Clips may be purchased.

OPERATING INSTRUCTIONS

TO LOWER PICTURE SURFACE

Pull screen down all the way. HESITATE – then allow screen to retract VERY SLOWLY until it locks in place.

TO RAISE PICTURE SURFACE

Pull down on the pull bail, then release quickly. The screen will retract gently into the case.

TO ADJUST RETRACTION SPEED

Use a large flat screwdriver to turn the adjustment knob on the right end of the screen. To increase the travel speed turn counterclockwise. To decrease the travel speed turn clockwise. Adjustments should be made in half turn increments and travel speed checked before adjusting further.

NOTE: This feature is not available on some large screen sizes. Call the factory for adjustment instructions.

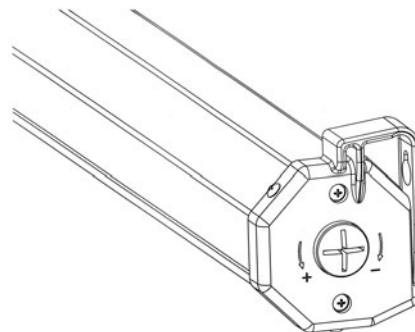

SCREEN ACCESSORIES

WALL BRACKETS (75# per pair maximum)

Da-Lite No. 6 and No. 11 Non-adjustable wall brackets and No. 23 adjustable extension wall brackets are ideal for keystone elimination, clearance, or corner mounting. The screen brackets should be fastened to the studding or other solid surface and not in the plaster only. Suspend screen from "D" rings.

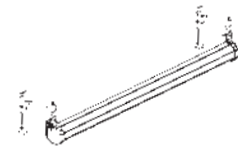

No. 23 ADJUSTABLE WALL BRACKETS

Screen can be extended 10"-24" from wall by wing nut and bolt adjustment.

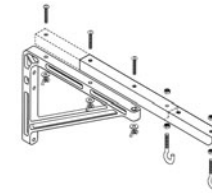

No. 11 WALL BRACKETS

Screen can be extended 10" or 14" from wall by changing position of bracket.

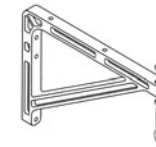

No. 6 WALL BRACKETS

Screen can be extended 6" from wall.

T-BAR CLIP For Drop Ceilings

50 lb. max. load capacity.

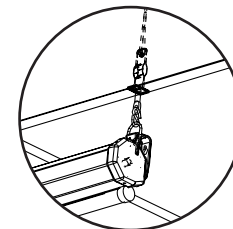

TILT LOCK For Keystone Elimination

Holds back bottom of screen in tilted position to eliminate keystoneing.

